

Veloce with Fascia (Front Crossbar)

Veloce Fascia exhibitors who have ordered and paid for the booth package, will be provided with a **Veloce hard wall with fascia** system, consisting of poplar plywood (painted white) panels white wooden framework including a front crossbar, and a double-sided street sign with company name and booth number.

Booth configurations vary for this type of booth package. Show Management provides a specific schematic for the contracted booth size. A standard 10' x 10' booth has an inside width dimension of 9' 7". A 10' x 10' constructed display will not fit within the confines of a 10' x 10' Veloce fascia hard wall booth package.

If you are taking the packaged booth option, please be advised that wooden (painted white) framework will be in place overhead, around the sides, and in front of your booth(s) as a means of support.

Where an exhibitor takes more than one space, support wall panels are provided as long as the request and an accompanying floor plan highlighting the position of the wall panels are received by the Operations Department on or before **July 5, 2024**.

Each Veloce with Fascia Booth Includes the Following:

- 8' high poplar wood panels (you are permitted to paint the walls yourself) – comes with a front crossbar.
- Black booth carpeting will be installed without exception.
- 1 Chair upon request only. If you would like a chair, complete the wastebasket & chair form [HERE](#).
- 1 Wastebasket upon request only. If you would like a wastebasket, complete the wastebasket & chair form [HERE](#).
- 1 Double sided sign with name and booth number.
- Lighting: See the table below for package specific light specifications. Power and labor for light fixtures is included.
- Drayage/Material handling consisting of crated and palletized shipments from the dock to the booth and the removal of freight at Show close. This does not include loose shipments, non-crated/non-palletized, small package shippers (Fed Ex, UPS, etc.) which will be subject to additional fees. Exhibitors are encouraged to ship crated or palletized to the Show.

Lighting Provided per Booth Size

Booth Size	Veloce Fascia Track Lighting-Halogen Fixtures
10x10	1 track – 4 lights
10x20	2 tracks – 4 lights per track
10x30	3 tracks - 4 lights per track

Booth Size	Veloce Fascia Track Lighting-Halogen Fixtures
10x40	4 tracks- 4 lights per track
20x20	4 tracks – 4 lights per track
20x30	6 tracks – 4 lights per track

5 x 10 INLINE WITH FASCIA

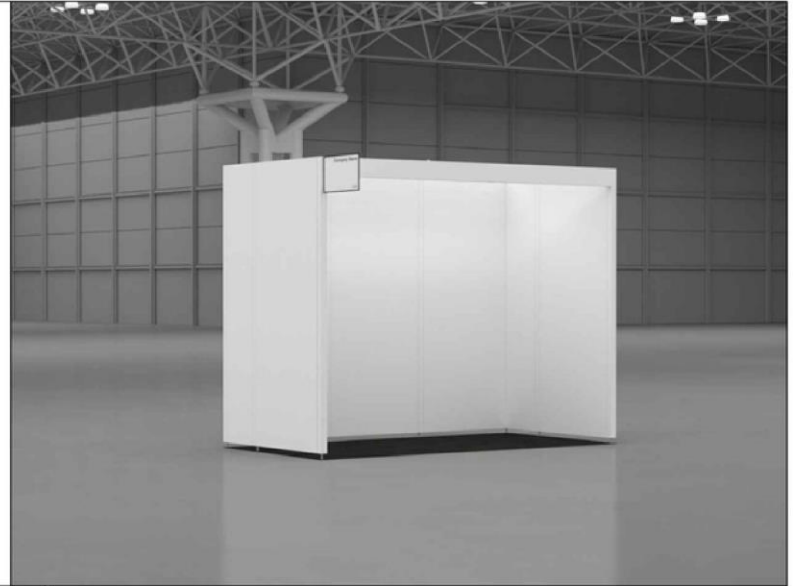
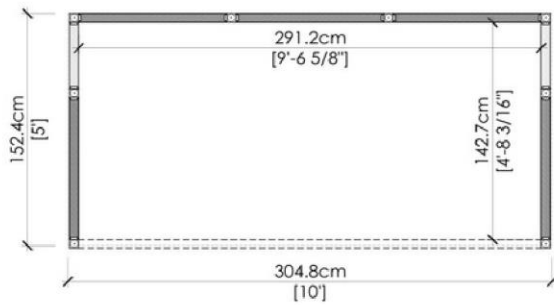

1 TOP VIEW

3 RENDERING

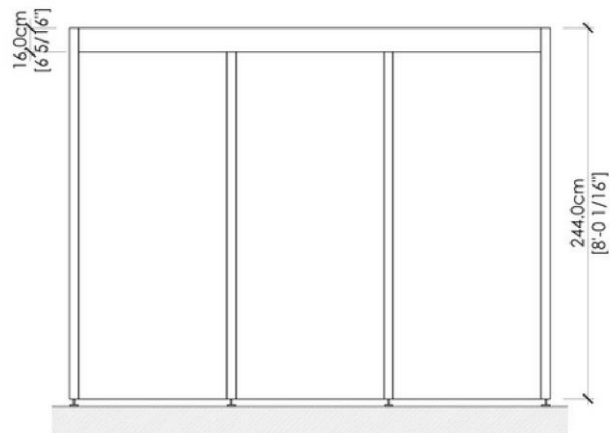

2 FRONT VIEW

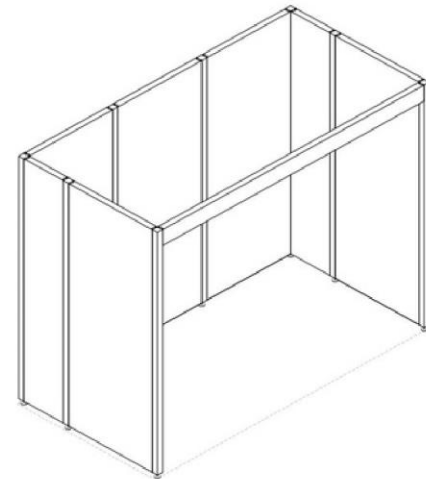

4 3D VIEW

5 x 10 CORNER WITH FASCIA

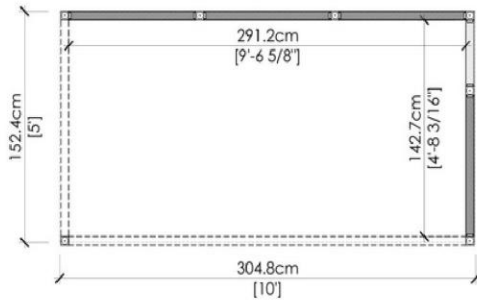

1 TOP VIEW

3 RENDERING

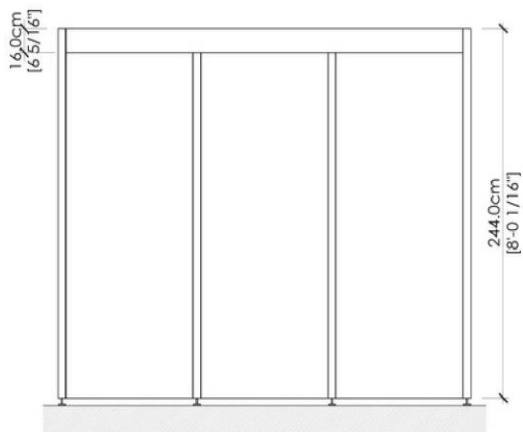

2 FRONT VIEW

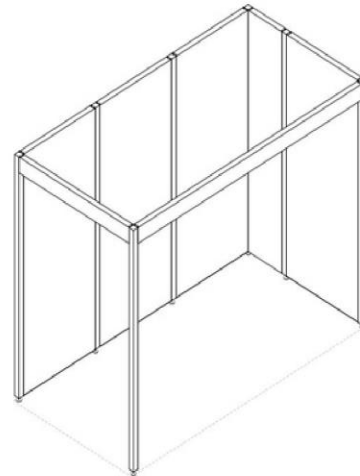

4 3D VIEW

5 x 15 INLINE WITH FASCIA

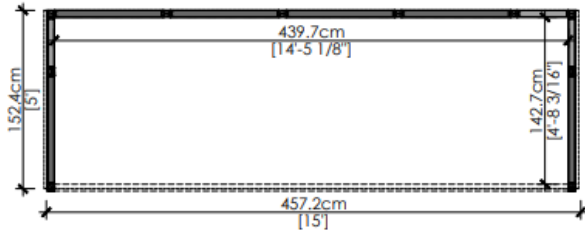

1 TOP VIEW

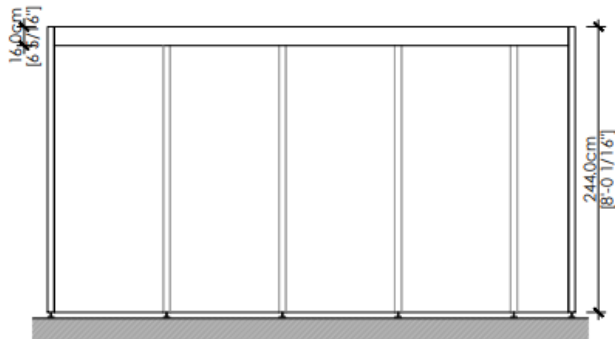

2 FRONT VIEW

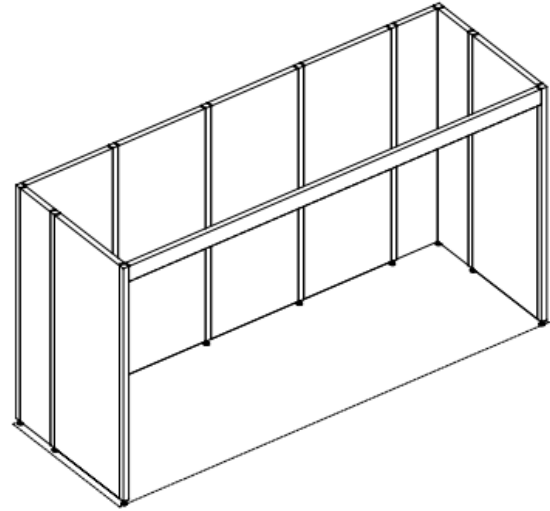

*VELOCE WOOD PANEL H:244cm [8'-0 1/16"]

3 3D VIEW

5 x 15 CORNER WITH FASCIA

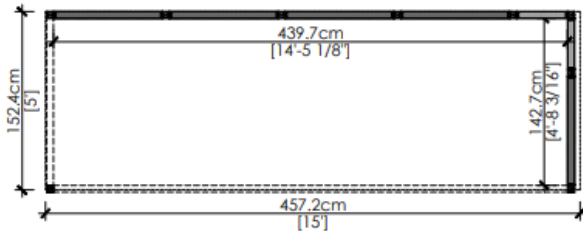

1 TOP VIEW

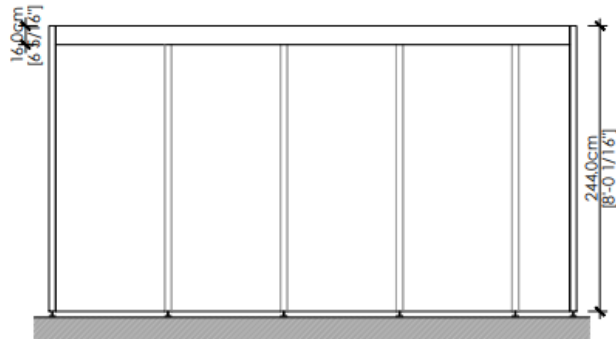

2 FRONT VIEW

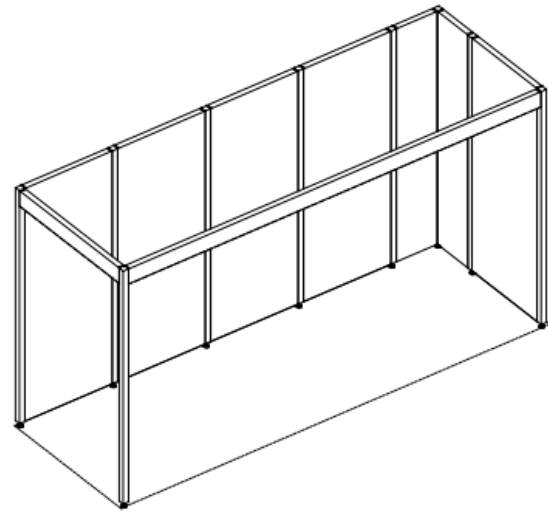

3 3D VIEW

*VELOCE WOOD PANEL H:244cm [8'-0 1/16"]

5 x 20 INLINE WITH FASCIA

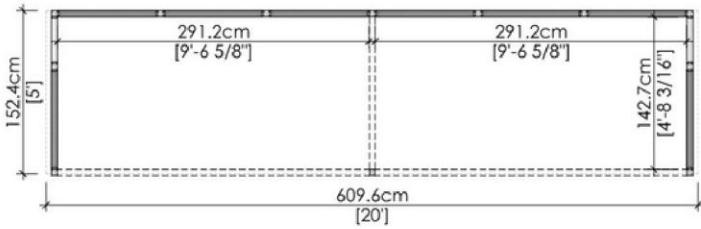

1 TOP VIEW

3 RENDERING

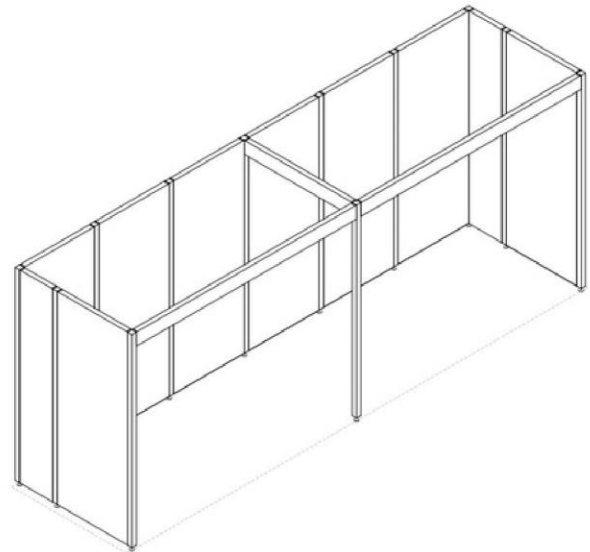
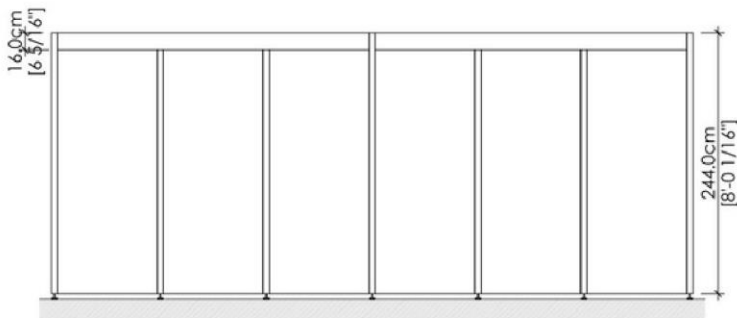

2 FRONT VIEW

4 3D VIEW

5 x 20 CORNER WITH FASCIA

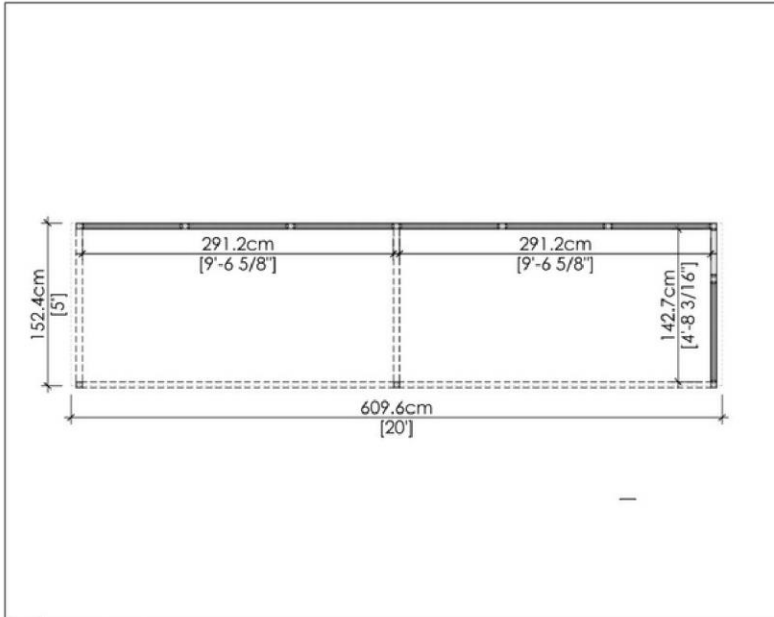

1 TOP VIEW



3 RENDERING

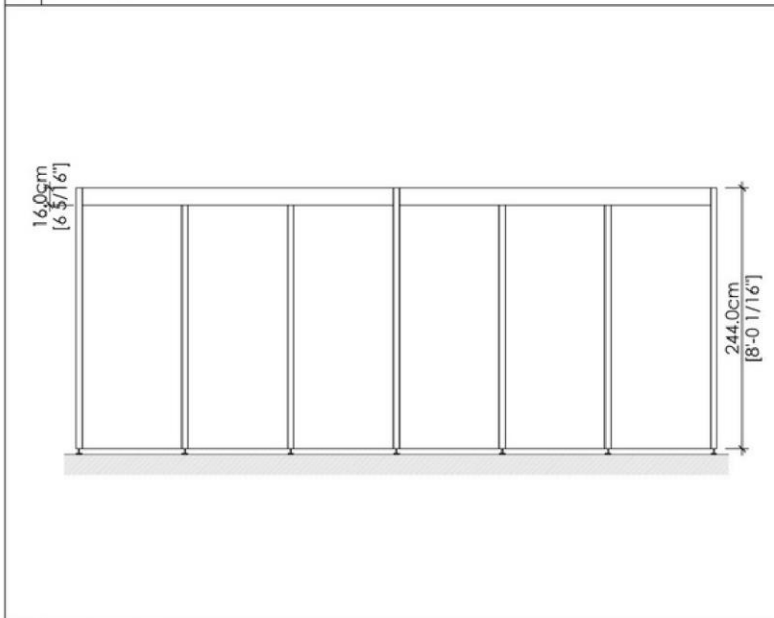

2 FRONT VIEW

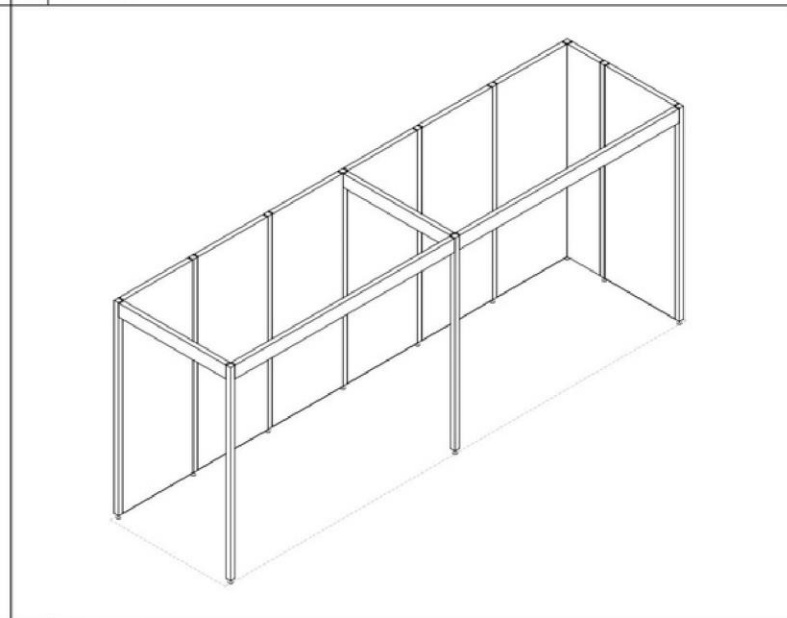

4 3D VIEW

10 x 10 INLINE WITH FASCIA

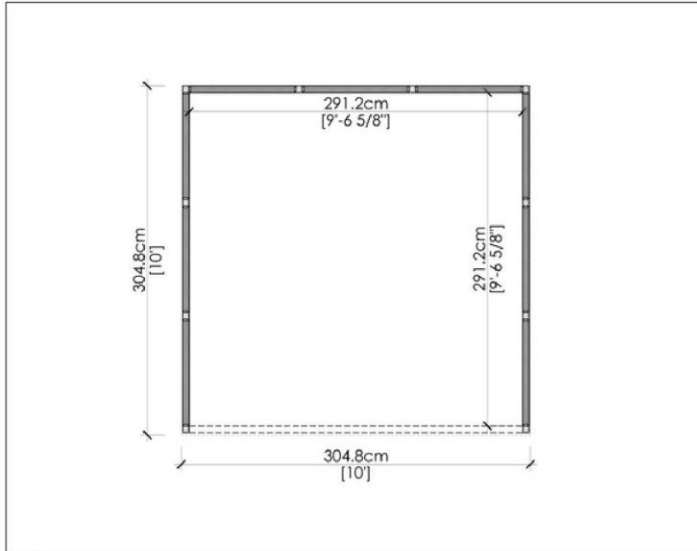

1 TOP VIEW

3 RENDERING

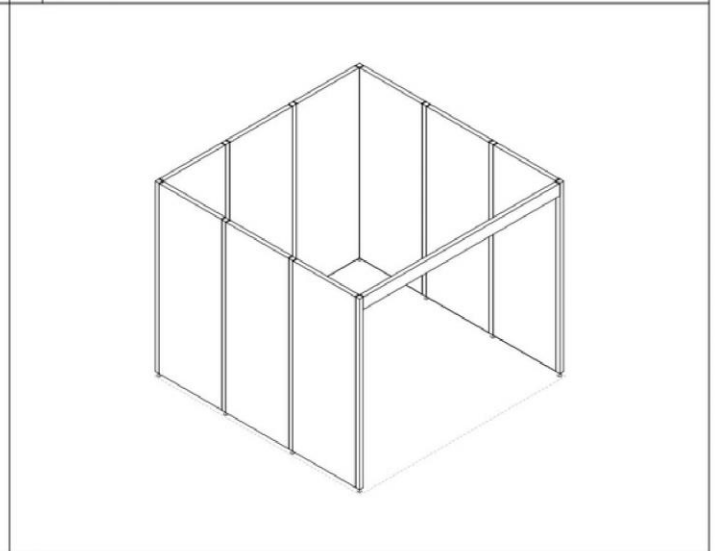
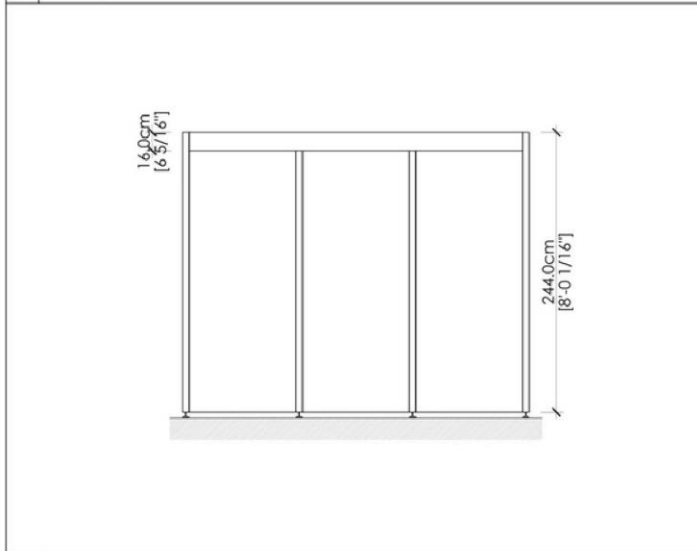

2 FRONT VIEW

4 3D VIEW

10 x 10 CORNER WITH FASCIA

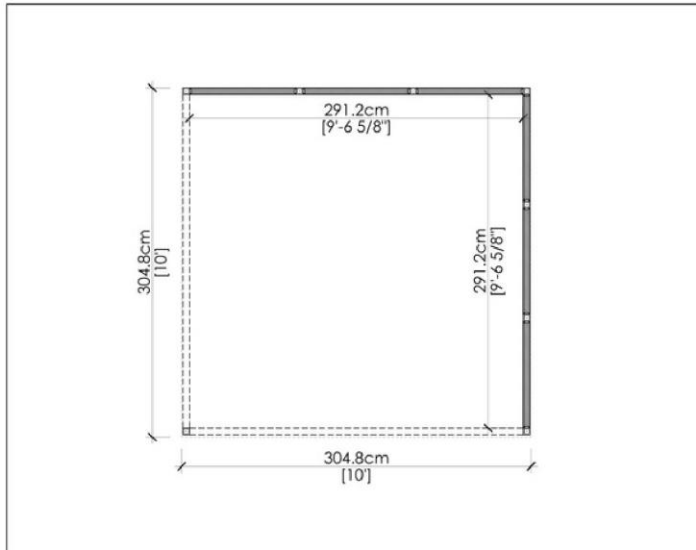

1 TOP VIEW



3 RENDERING

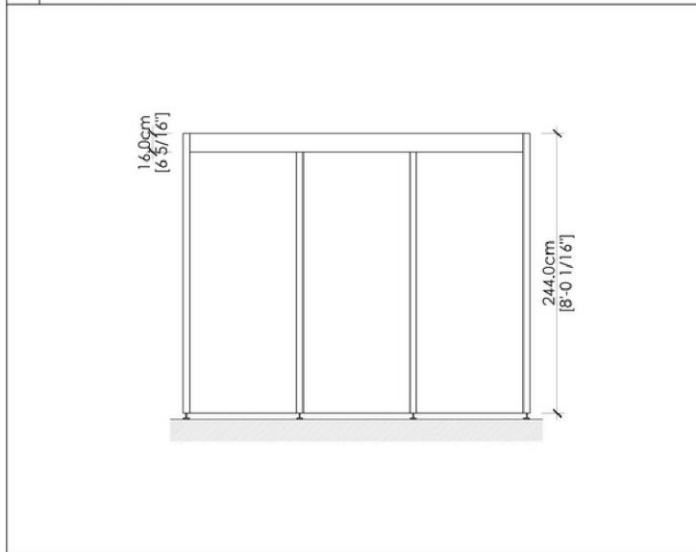

2 FRONT VIEW

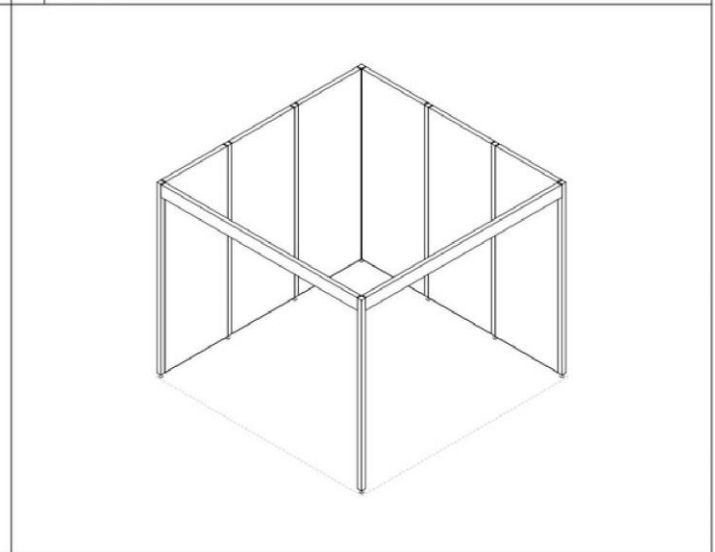

4 3D VIEW

10 x 15 INLINE WITH FASCIA

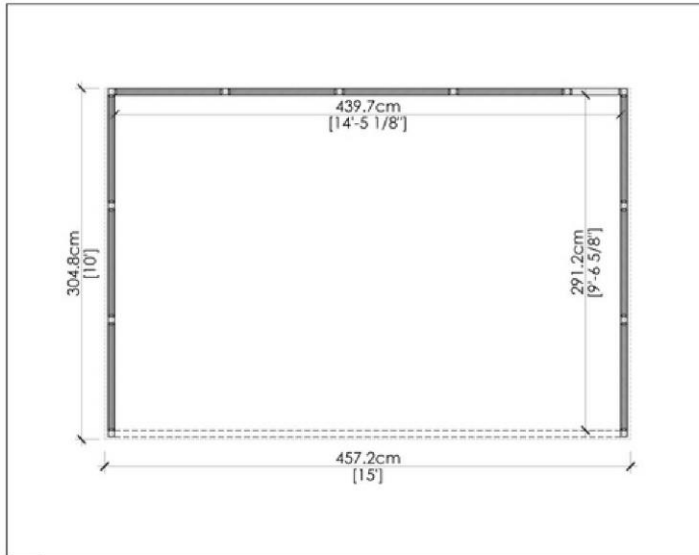

1 TOP VIEW



3 RENDERING

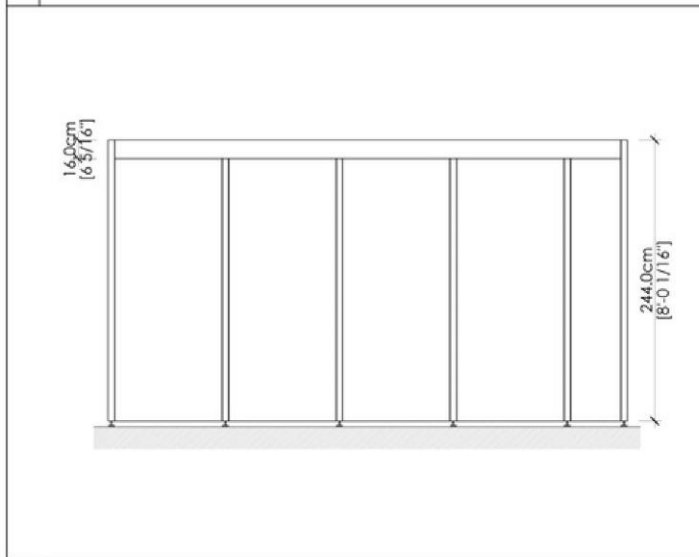

2 FRONT VIEW

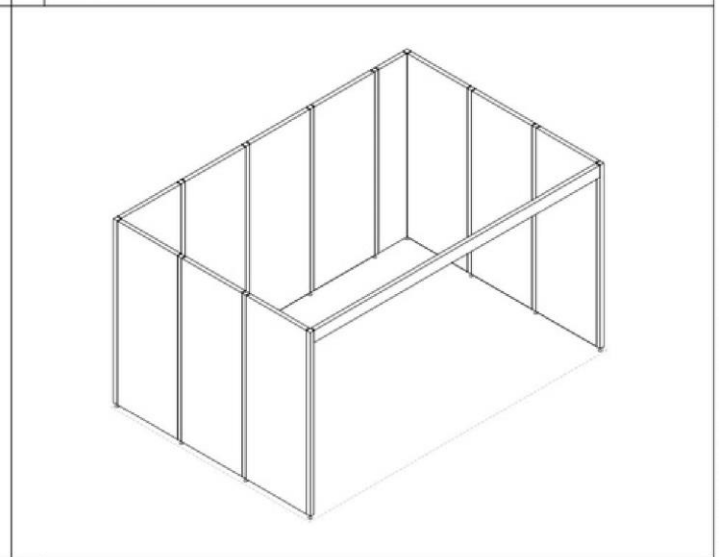

4 3D VIEW

10 x 15 CORNER WITH FASCIA

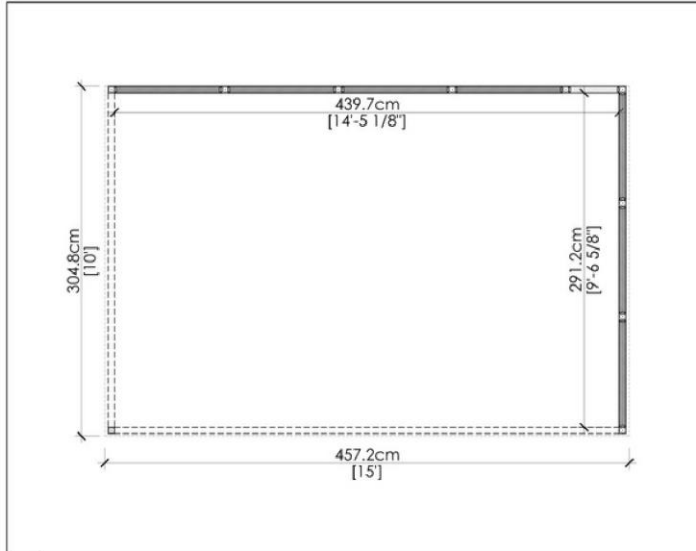

1 TOP VIEW



3 RENDERING

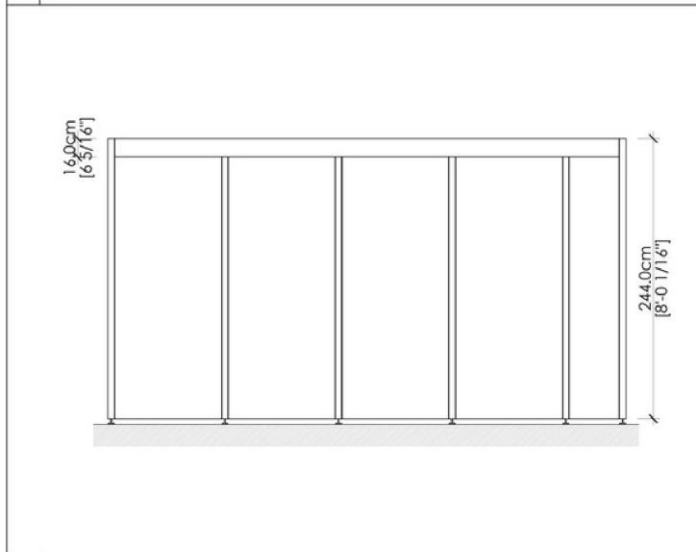

2 FRONT VIEW

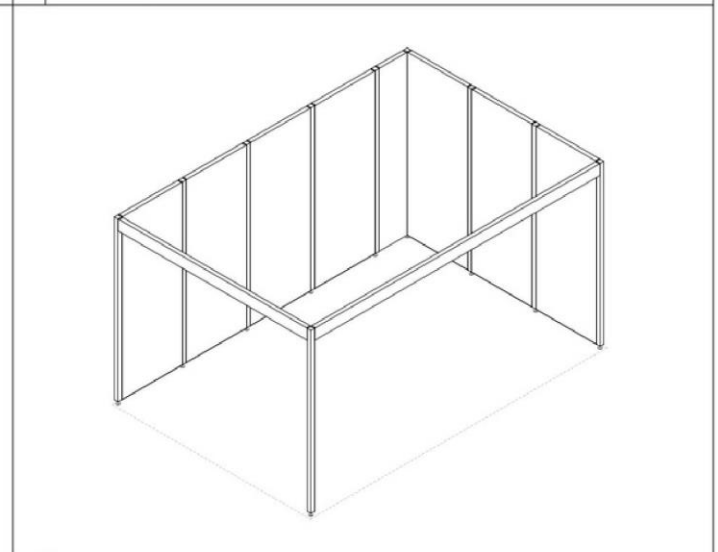

4 3D VIEW

10 x 20 INLINE WITH FASCIA

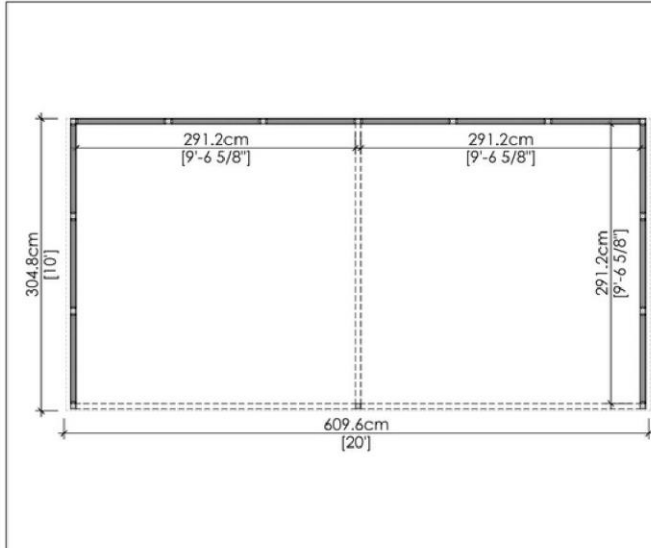

1 TOP VIEW



3 RENDERING

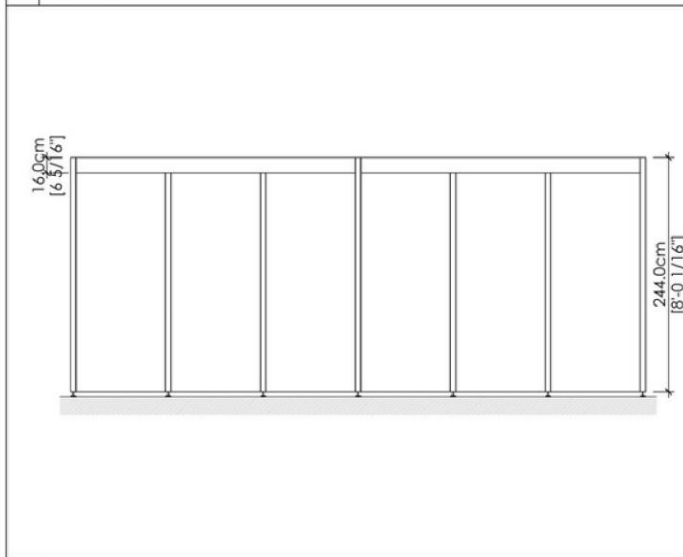

2 FRONT VIEW

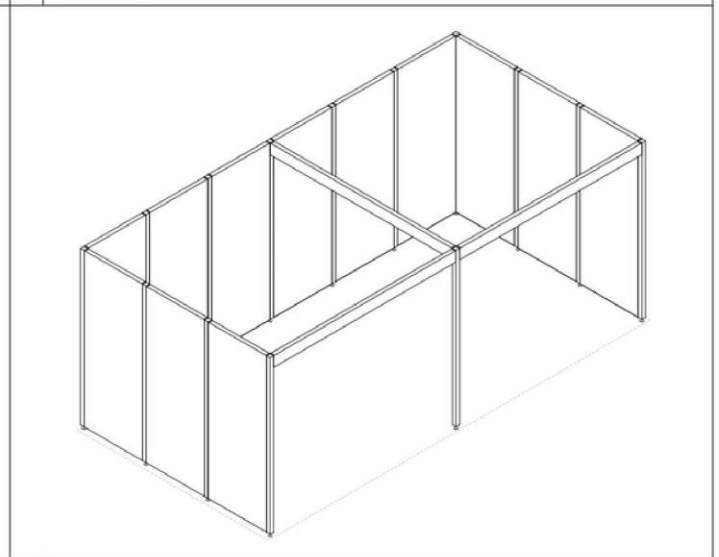

4 3D VIEW

10 x 20 CORNER WITH FASCIA

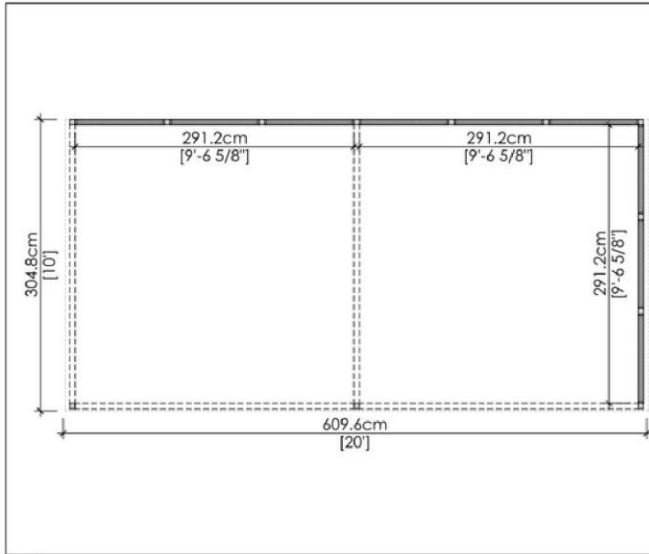

1 TOP VIEW

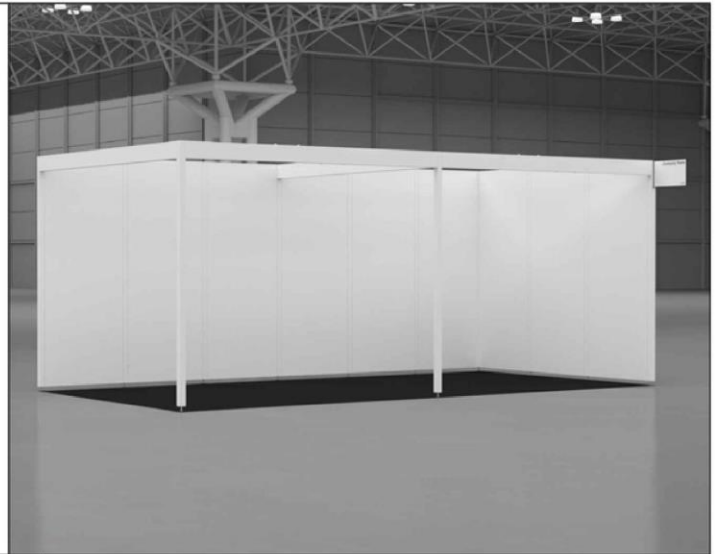

3 RENDERING

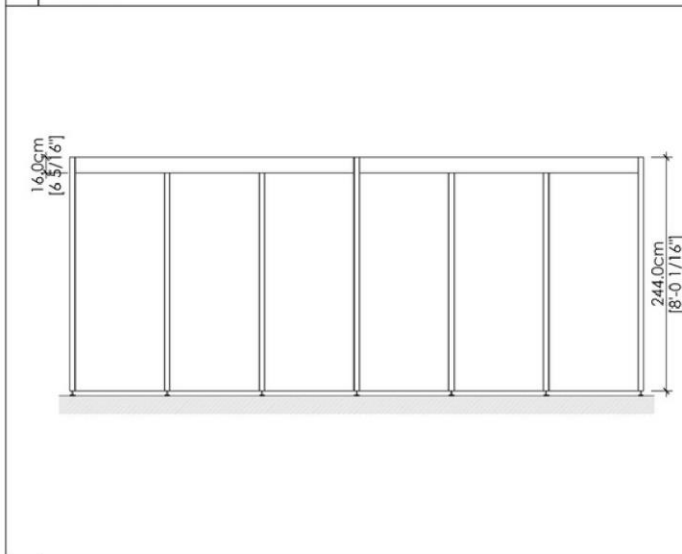

2 FRONT VIEW

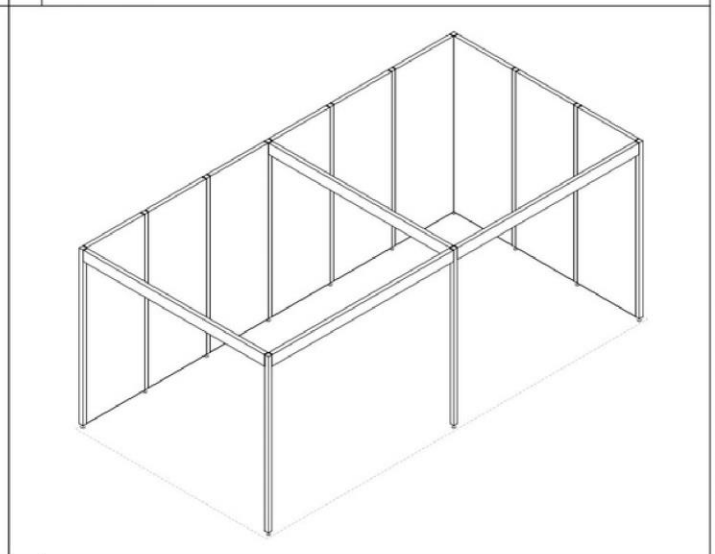

4 3D VIEW

10 x 25 INLINE WITH FASCIA

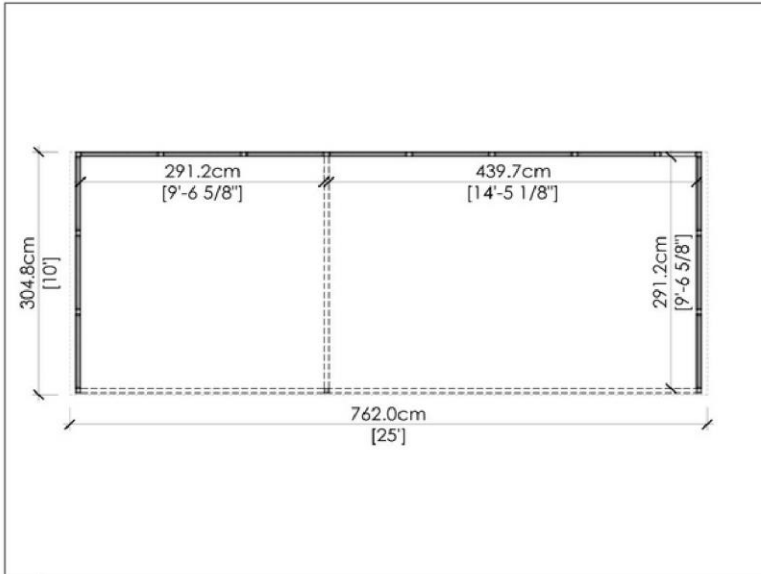

1 TOP VIEW

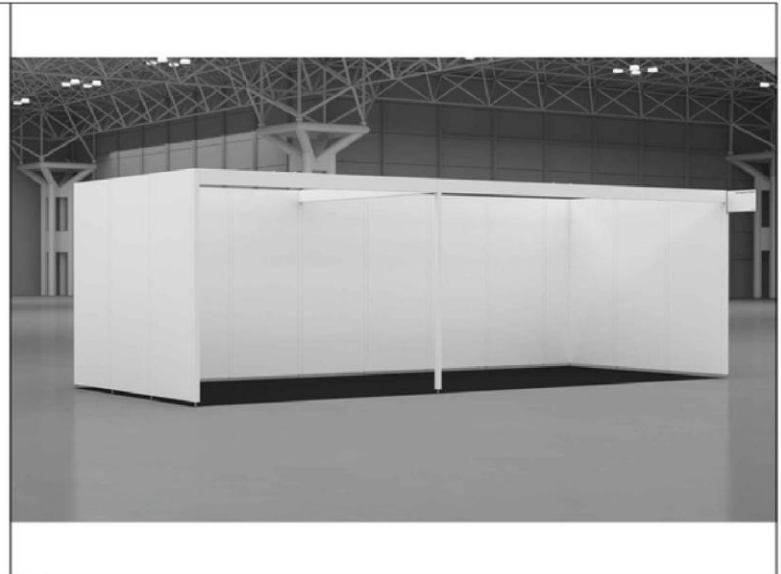

3 RENDERING

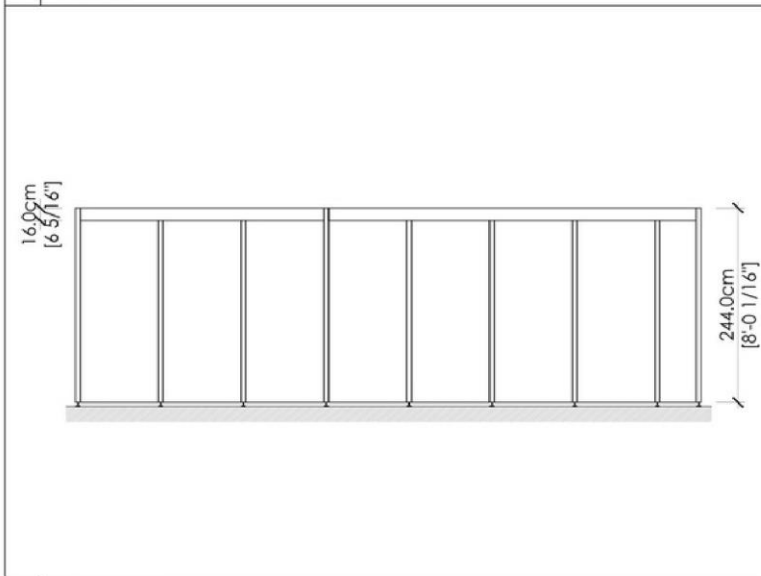

2 FRONT VIEW

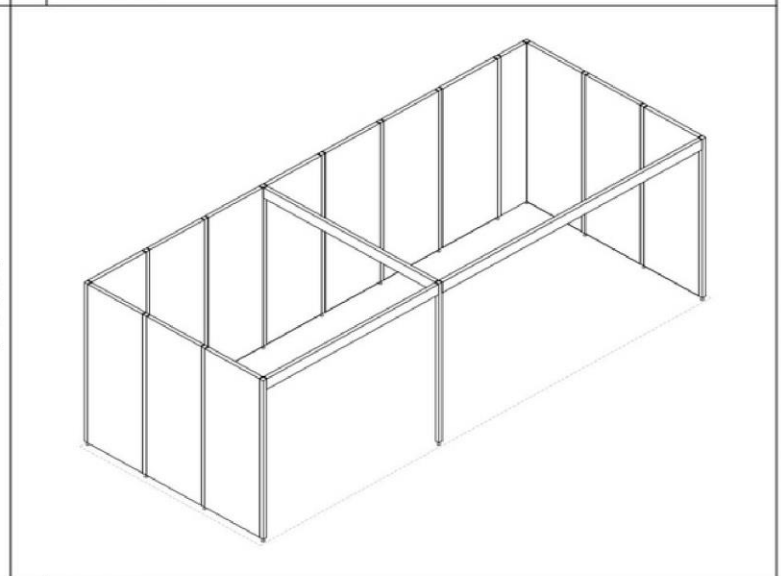

4 3D VIEW

10 x 25 CORNER WITH FASCIA

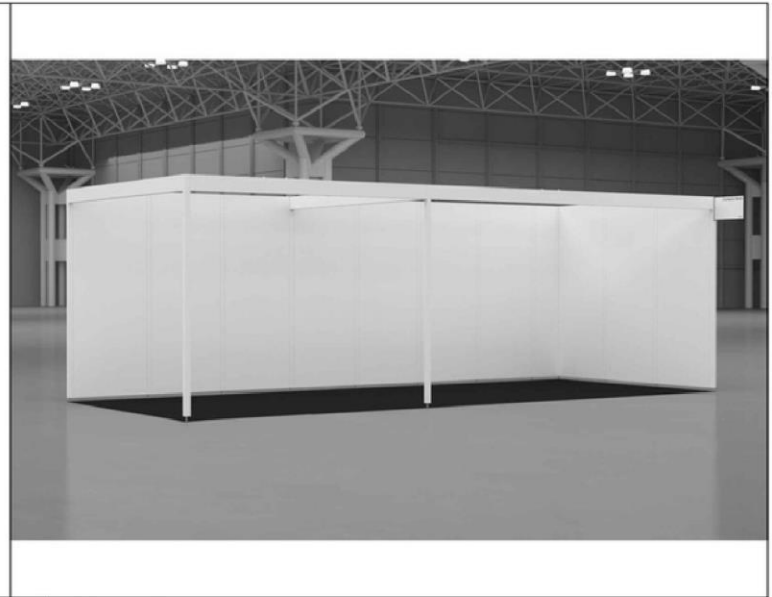
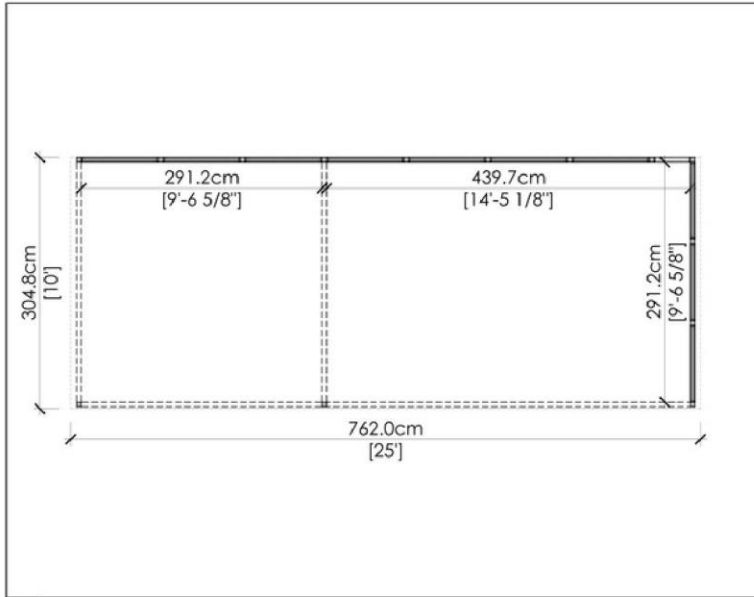

1 TOP VIEW

3 RENDERING

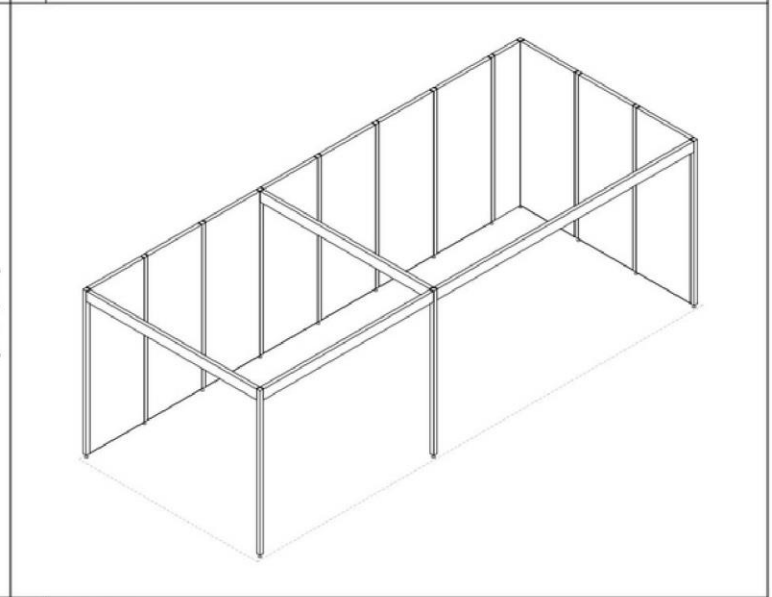
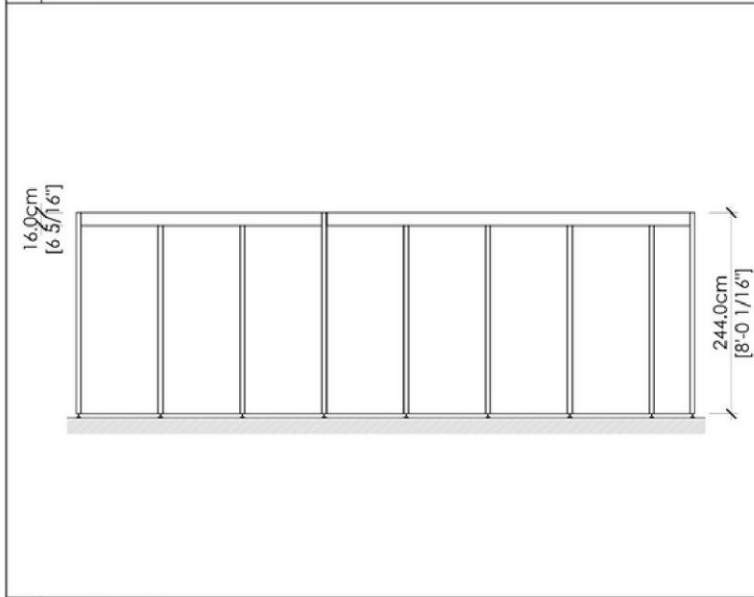

2 FRONT VIEW

4 3D VIEW

10 x 30 INLINE WITH FASCIA

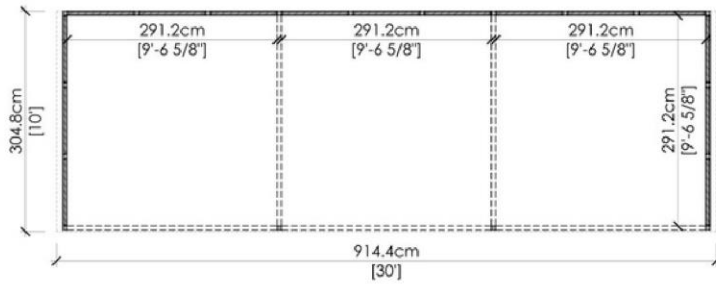

1 TOP VIEW

3 RENDERING

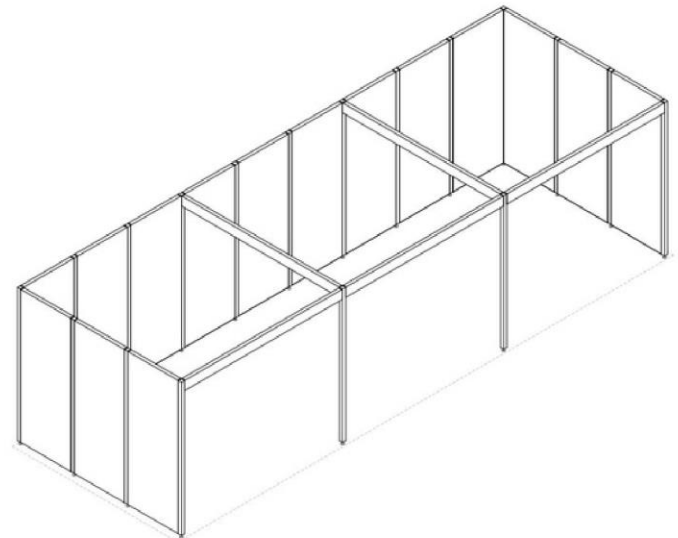
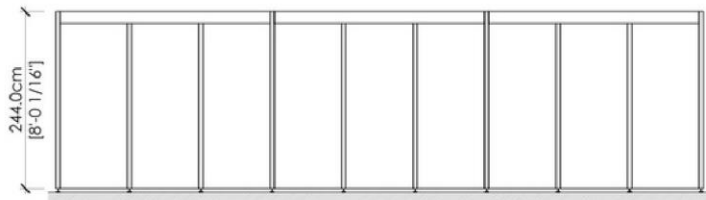

2 FRONT VIEW

4 3D VIEW

10 x 30 CORNER WITH FASCIA

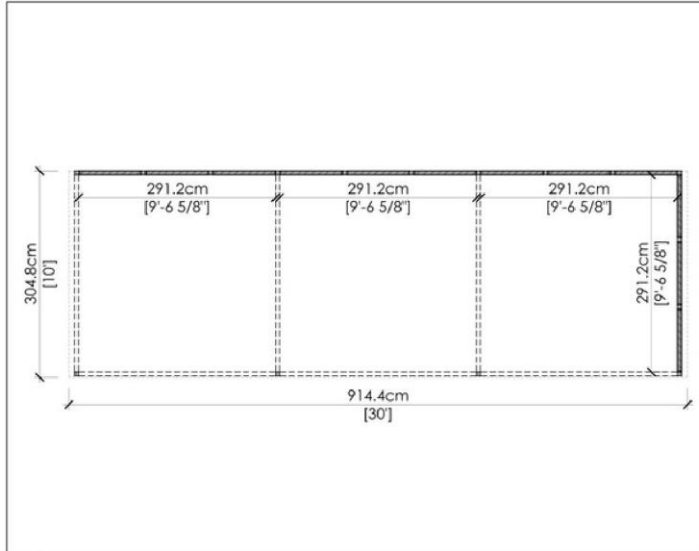

1 TOP VIEW

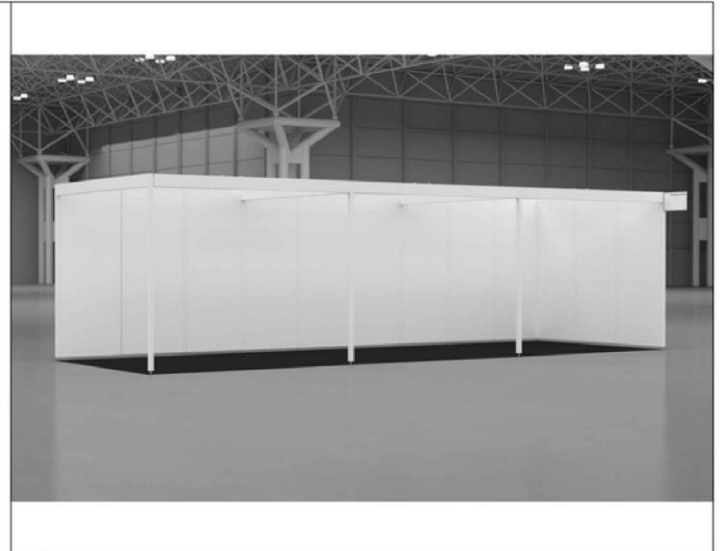

3 RENDERING

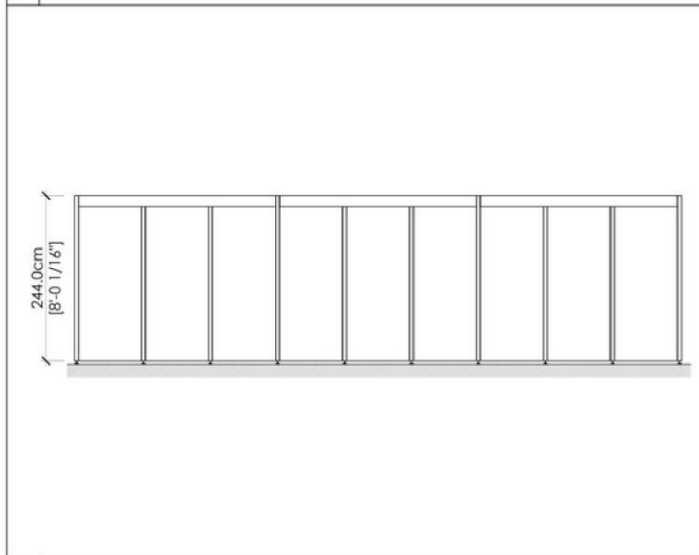

2 FRONT VIEW

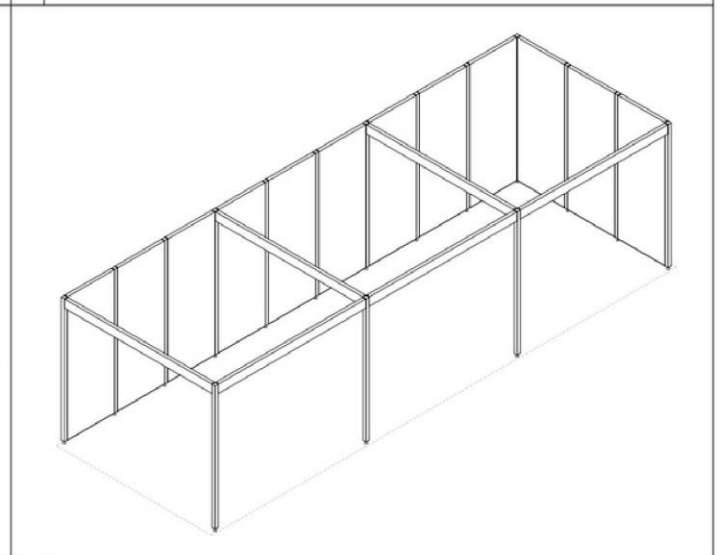

4 3D VIEW

10 x 40 INLINE WITH FASCIA

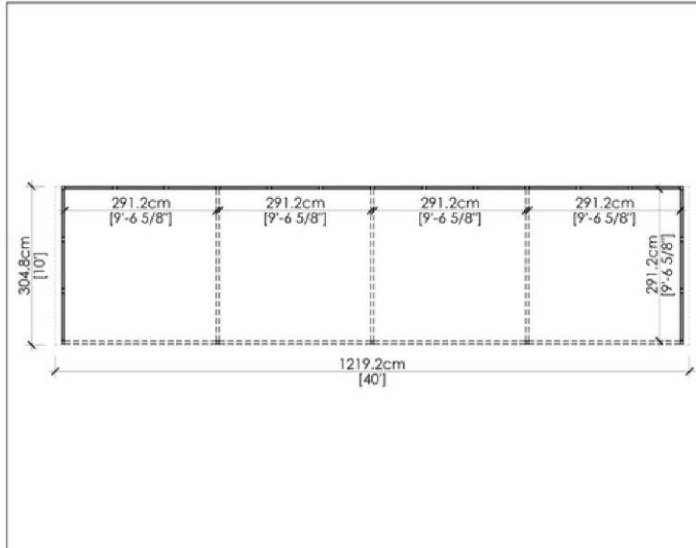

1 TOP VIEW



3 RENDERING

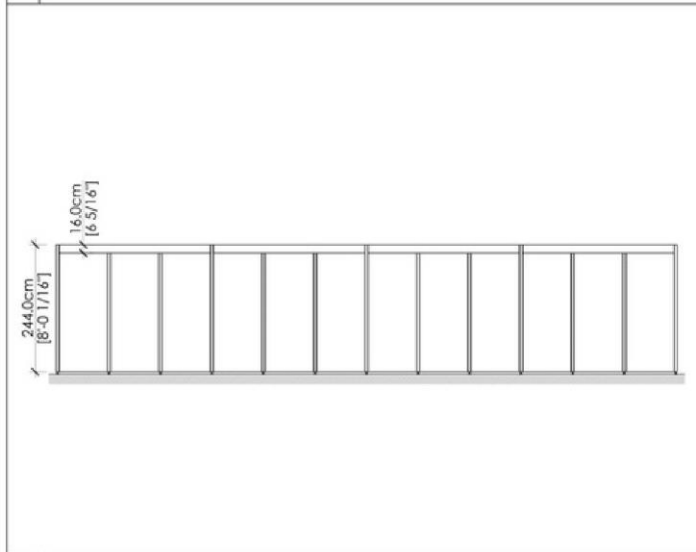

2 FRONT VIEW

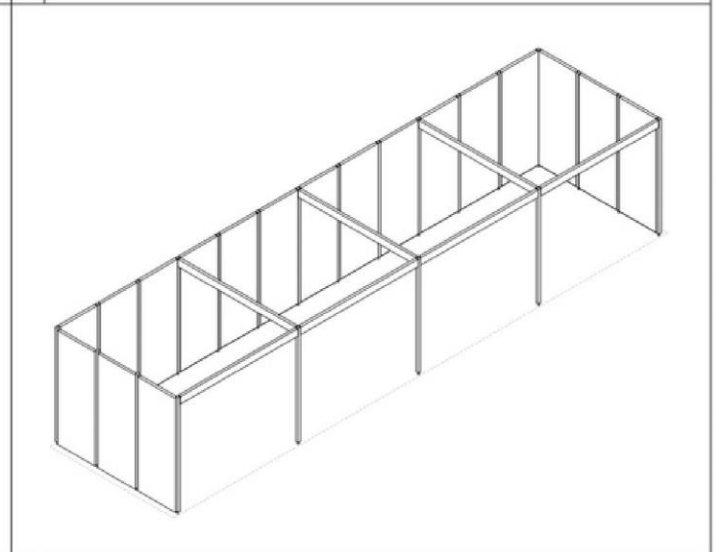

4 3D VIEW

10 x 40 CORNER WITH FASCIA

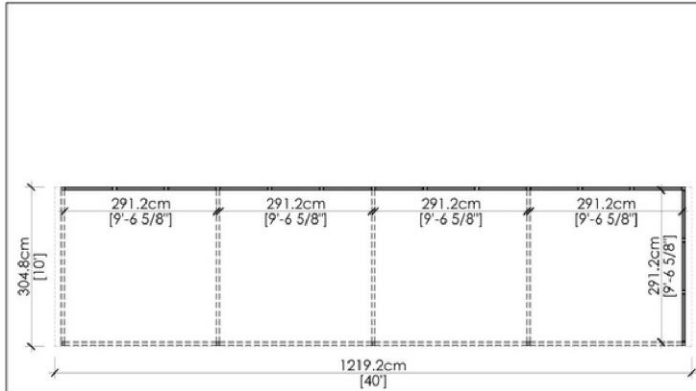

1 TOP VIEW



3 RENDERING

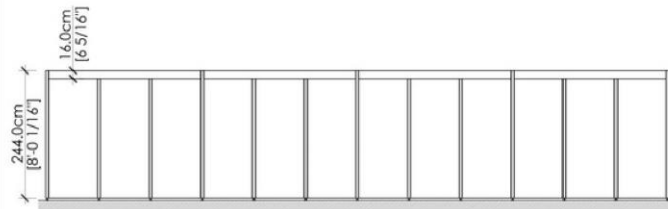

2 FRONT VIEW

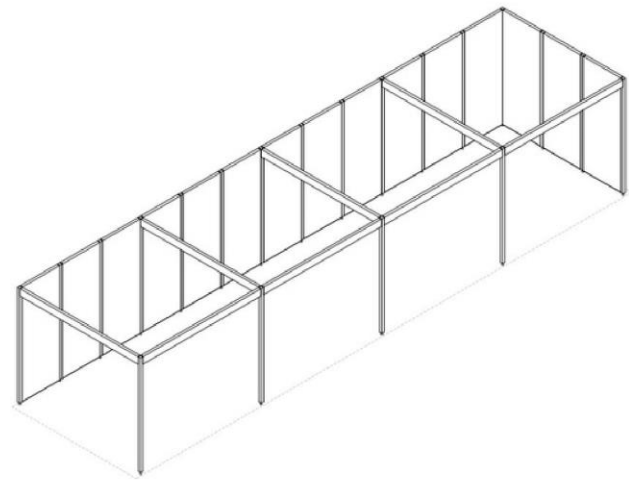

4 3D VIEW

10 x 40 CORNER WITH FASCIA

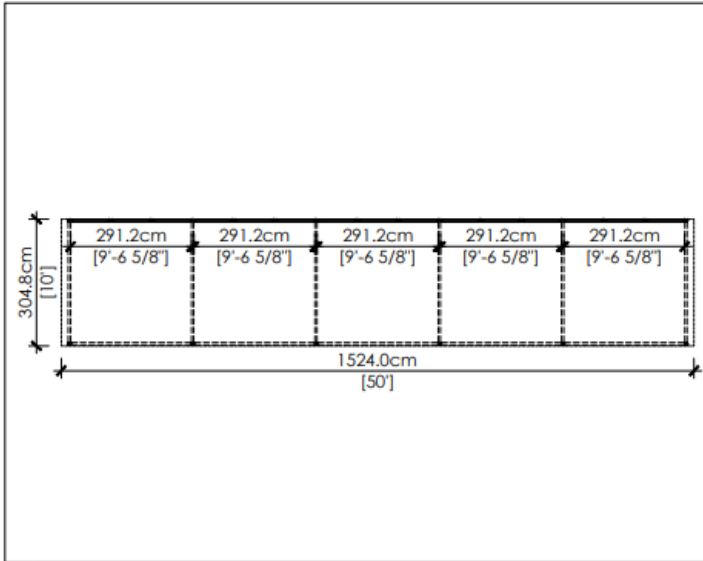

1 TOP VIEW

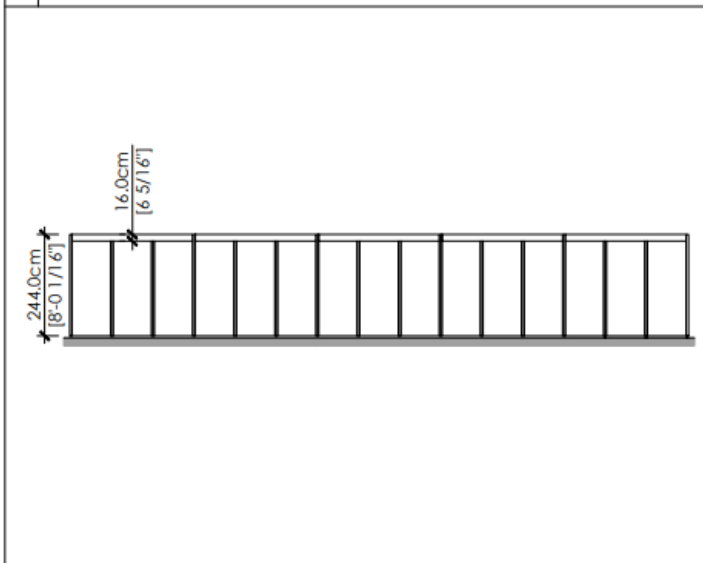

2 FRONT VIEW

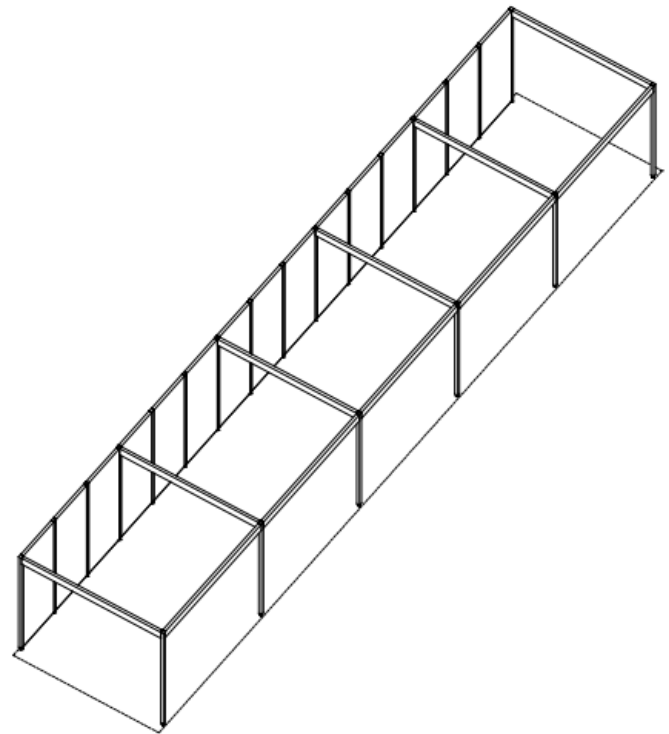

*VELOCE WOOD PANEL H:244cm [8'-0 1/16"]

4 3D VIEW

15 x 20 INLINE WITH FASCIA

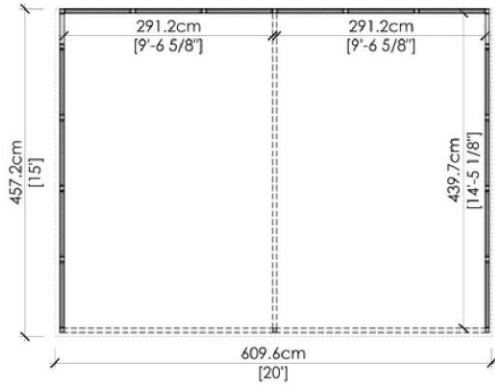

1 TOP VIEW

3 RENDERING

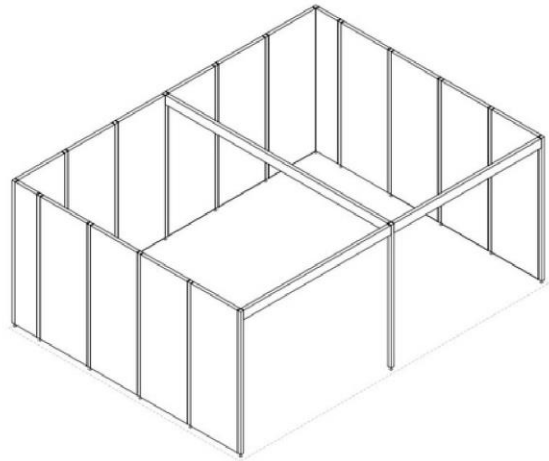
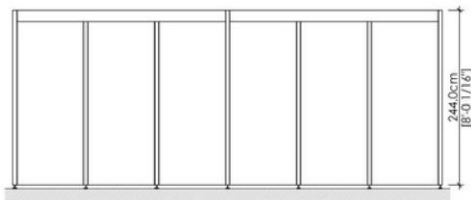

2 FRONT VIEW

4 3D VIEW

15 x 20 CORNER WITH FASCIA

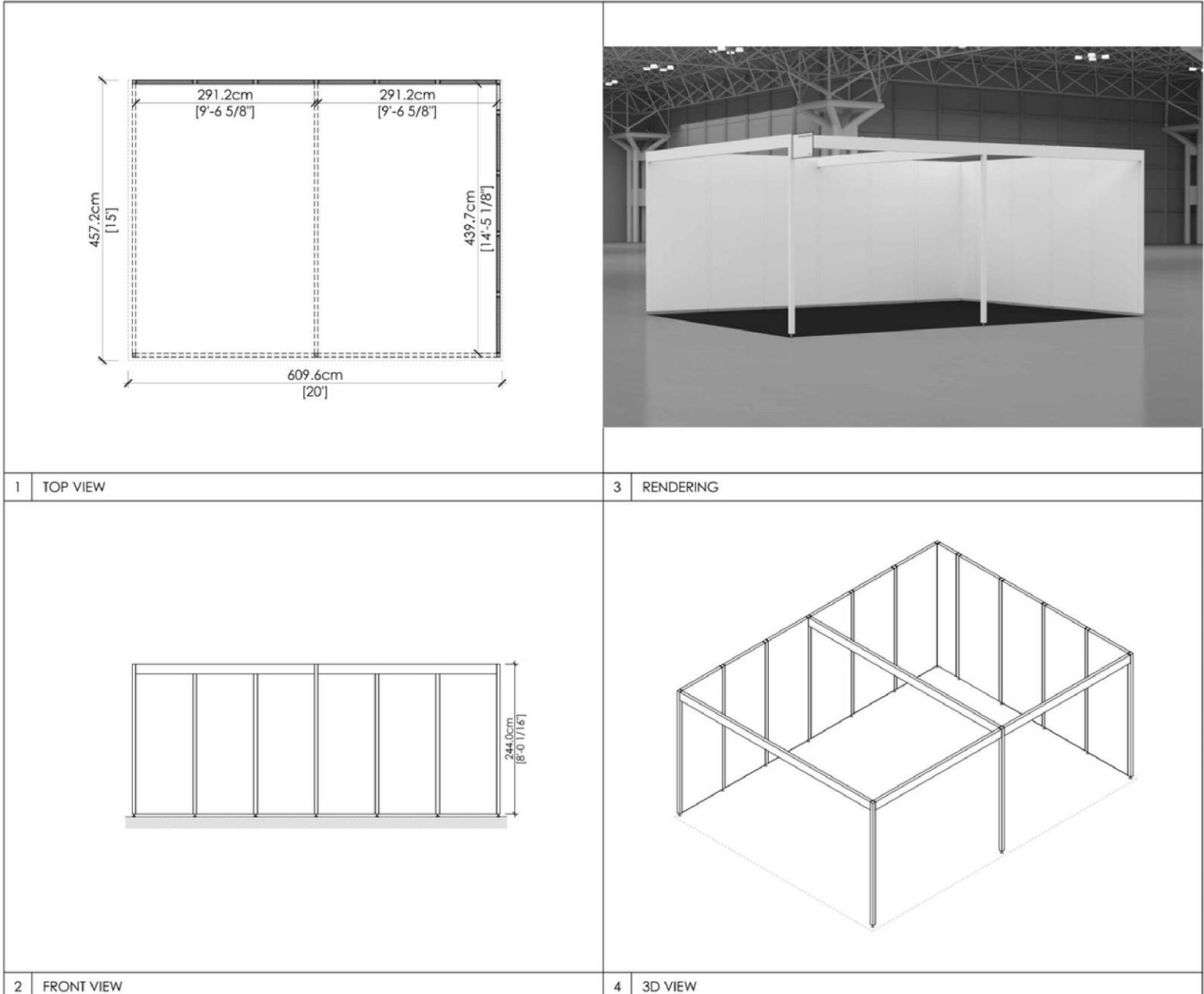

20 x 25 CORNER WITH FASCIA

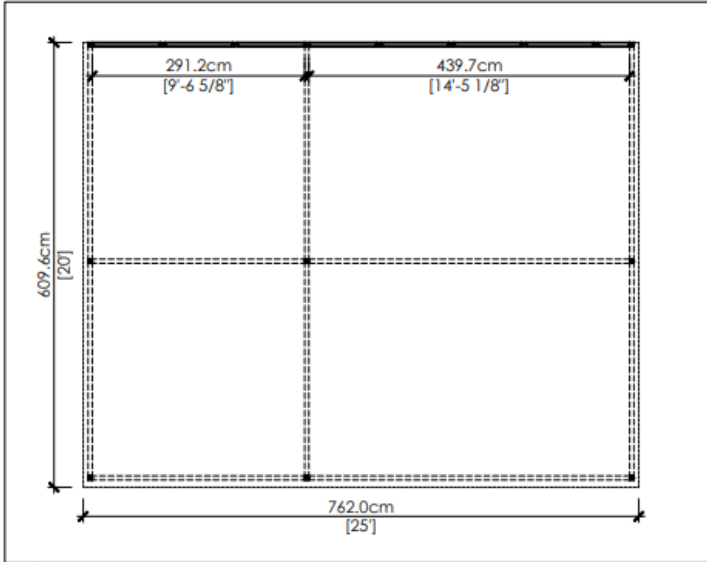

1 TOP VIEW

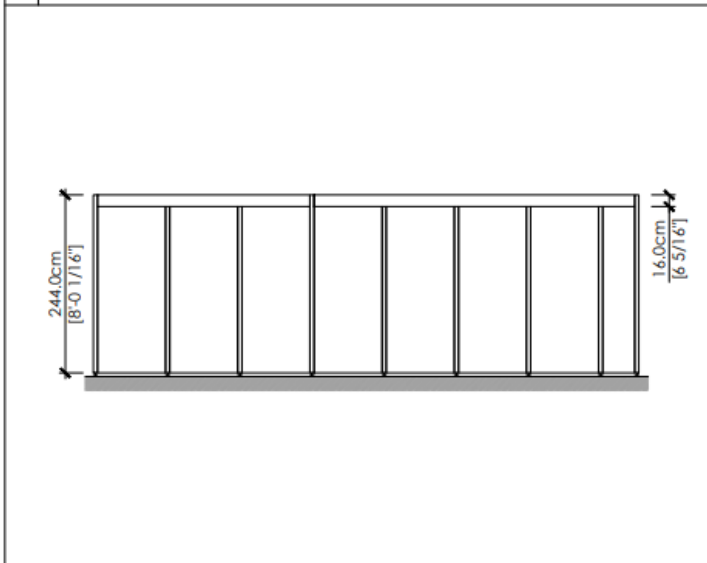

2 FRONT VIEW

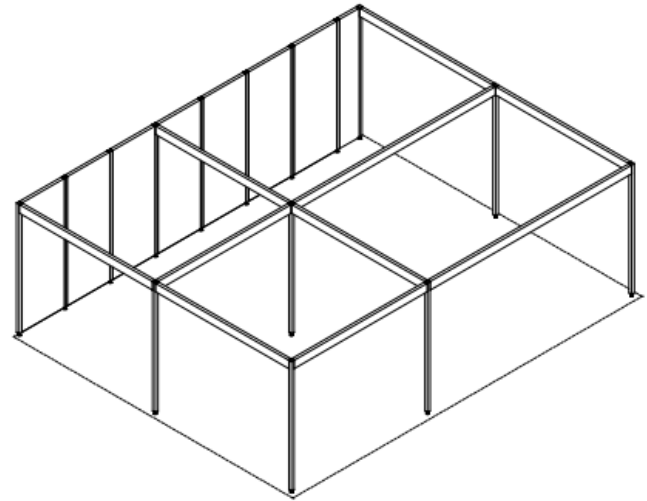

4 3D VIEW

*VELOCE WOOD PANEL H:244cm [8'-0 1/16"]